

## Protects your system against GPS Spoofing & Jamming

AccuBeat's patented Time FireWall™ is a 19" 1U unit which is easily inserted between the user's antenna and the user's existing GNSS (GPS) receiver.



### Key Features

- Delivers continuous & valid GPS signals even under jamming or spoofing attacks
- Add on - Plug & Play solution Provides a spoofing alert
- Built in Rubidium atomic clock
- Nano-seconds accuracy
- Timing drift under attack: 40ns / hour
- 1PPS Accuracy: 40ns RMS @ 25°C
- Outputs (10MHz, 1PPS, TOD)
- External 1PPS / Frequency input for disciplining
- Input : GPS L1 band antenna
- Output : GPS L1 band signals
- 19" 1U Rack mounted unit
- Redundant Supply Voltage: 85 – 264 VAC or 120 – 370 VDC input
- Monitor & control: RS232, UDP
- Graphic User Interface (GUI) Software for PC
- Command Line Interface
- LAN interface
- Support the following networking protocols:  
SYSLOG, HTTP/SSL, SSH-V2, RADIUS, TACACS, SNMP3, SMTP, LDAP, MD5
- Patented solution, number 235356

### Description

The **Time FireWall™** receives a GNSS (GPS) signal from the antenna and performs an integrity test on the signal using a local Rubidium clock and other proprietary methods. As long as the GNSS signal is found to be authentic, the Time FireWall™ enables the GNSS signal to pass through to the output receiver. If the Time FireWall™ determines that the GNSS signal is unreliable (due to jamming, spoofing or any other malicious attacking), it sends a warning alarm and simulates an alternate GPS signal with timing derived from the local Rubidium clock operating in "Holdover" mode. This action allows continuous and uninterrupted timing and synchronization signals even in a GNSS denied or spoofed environment. The Time FireWall™ support several networking protocols such as: SYSLOG, HTTP/SSL, SSH-V2, RADIUS, TACACS, SNMP3, SMTP, LDAP, MD5.

All specs are at room temperature, quiescent conditions, sea level ambient unless otherwise specified

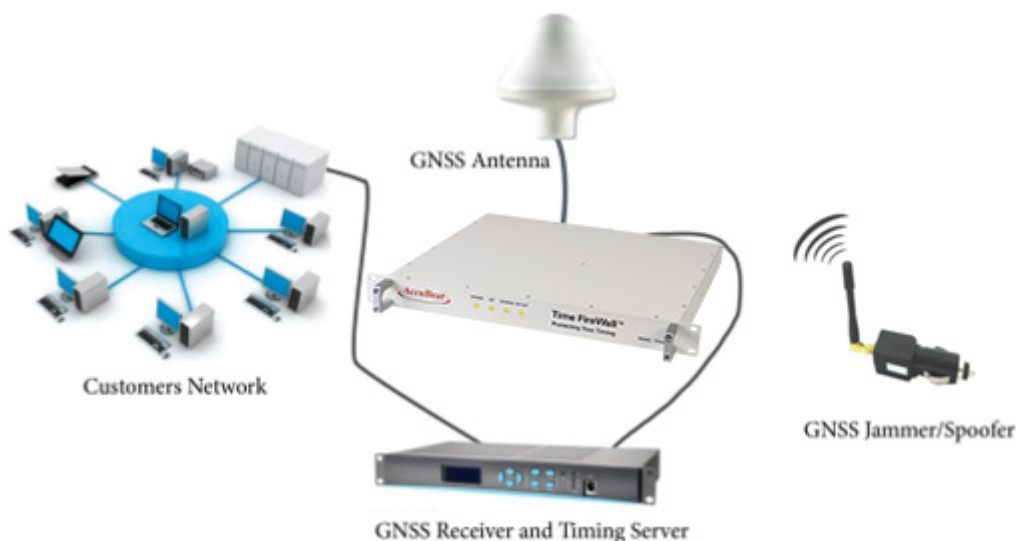

**Unprotected customer system:**

The GPS antenna is connected directly to the Timing system without any protection and is vulnerable to spoofing or jamming attack

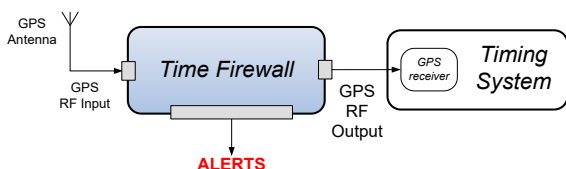

**Protected customer system with Time FireWall™:**

The Time FireWall protects the customer's system against spoofing and jamming attacks and sends an alert on detection of an attack

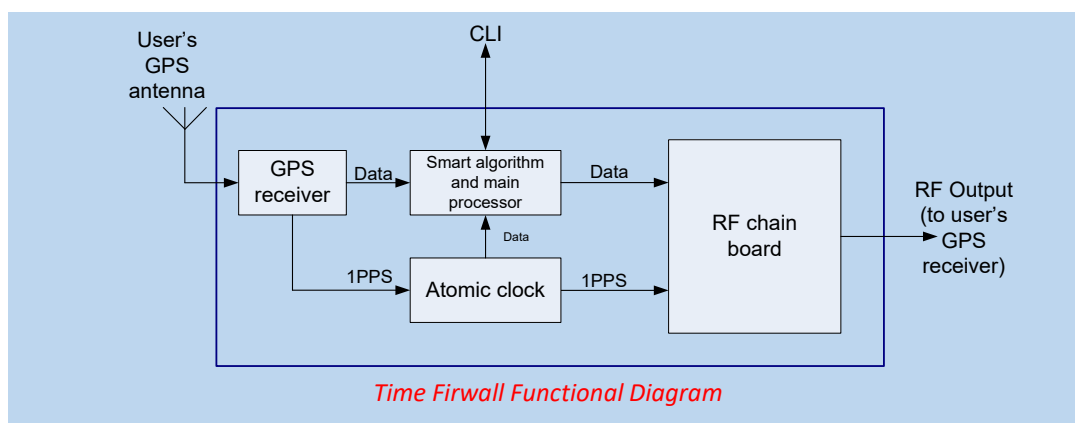

*Time Firwall Functional Diagram*

In the Time FireWall™ there are two RF outputs: the Validate output and the Protected output:

**Protected output**

The Validate signal is connected to the RF In signal, in case of suspect to spoofing or spoofing the RF In signal will be disconnected and the output will turn to open mode.

**Validate output**

The Protected signal is connected to the RF In signal, in case of suspect to spoofing or spoofing the RF In signal will be disconnected and an alternate GPS signal with timing derived from the local Rubidium clock operating in "Holdover" mode will be connected.

All specs are at room temperature, quiescent conditions, sea level ambient unless otherwise specified

Inputs & Outputs	
Power Input (J1,J2)	AC or DC input J1, J2 85 – 264 VAC, 50/60Hz OR 120 – 370 VDC
RF In (J3)	GNSS Antenna – TNC Connector RF input level: -100dBm to -145dBm DC output (for active antenna): 5V
J4	LAN connection
J5	Console connection
J6	10MHz out
J7	1PPS out
J8	TOD out (Time OF Day , protocol Have Quick)
J9	SYNC IN
J10	TOD in (Time OF Day in, protocol Have Quick)
Validate RF OUT (J11)	GPS RF signals (L1 band) – BNC Type connector RF level: -130dBm $\pm$ 5dB Output DC voltage: 0V (DC blocked)
Protected RF OUT (J12)	GPS RF signals (L1 band) – BNC Type connector RF level: -130dBm $\pm$ 5dB Output DC voltage: 0V (DC blocked)

All specs are at room temperature, quiescent conditions, sea level ambient unless otherwise specified

Performance (Rubidium Mode)		
Frequency	Short Term Stability (ADEV)	Standard
		< 3E-11 @ 1s
		< 1E-11 @ 10s
		< 5E-12 @ 100s
	Phase Noise	< 2E-12 @ 1000s (Typ.)
		<-102 dBc/Hz @ 10Hz
		<-135 dBc/Hz @ 100Hz
		<-145 dBc/Hz @ 1kHz
	Harmonics	<-150 dBc/Hz @ 10kHz
		< -44 dBc (up to 70MHz)
	Spurious	< -80 dBc in the range
		10Hz to 100kHz from carrier
Warm-up	< 5E-8 (Lock) within 4 minutes @ 25°C	
	±5E-10 within 5 minutes @ 25°C	
Retrace	< 5E-11 with on-off-on cycle: 24 hours, 48 hours, 12 hours	
Accuracy @ Shipment	< 5E-11	
Magnetic Field Sensitivity	< 8E-11 / gauss up to 3 gauss DC (worst direction)	
Long Term Stability (Free run)	<±1E-10 / month (after 3 months of operation)	
Long Term Stability (Disciplined to external 1PPS)	<±2E-12 (24 hrs average)	
Temperature Stability and Range	±3E-10 over -20°C to +65°C	
Time Accuracy (1PPS)	Long- Term Accuracy	1µs / 24 hours (after disciplining/calibration) typical @ 25°C
		Disciplined to external 1PPS - 40ns (20ns typical) RMS @ 25°C

(\*) Unless specified, all parameters relate to 10MHz main output.

All specs are at room temperature, quiescent conditions, sea level ambient unless otherwise specified

Environmental	
Operating Temperature	-20°C to +65 °C
Storage Temperature	-20°C to +70°C
Humidity	Up to 95% at 35°C, non-condensing
Vibration (Transportation)	2.5g RMS

Front panel LED indications and GUI	
LED Indications	<p>4 LEDs on the front panel: Power, BIT, Source, RF OUT</p> <p>POWER – Green, power supply is conected</p> <p>BIT – Green blinking, during power up tests Green, the system work properly Red, the bit tests failed</p> <p>SOURCE – LED turned off, the system doesn't reach satellite yet Green, the system locked on satellite Green blinking, suspect of spoofing</p> <p>RF OUT – LED turned off in the following two condition:</p> <ol style="list-style-type: none"> <li>1. on power up until system start transmit GPS signal</li> <li>2. if there is a problem that the system can't transmit the GPS signal which is not suspect to spoofing or spoofing mode Green blinking the system transmit GPS signal Green, GPS signal pass loopback test Red, suspect to spoofing or spoofing mode without the ability transmit GPS signal</li> </ol>
<p>Graphic User Interface (GUI) – option</p> <p>(The GUI is software for PC used for maintenance and as a starter kit)</p>	<ul style="list-style-type: none"> <li>○ Time / date display</li> <li>○ Satellites in view</li> <li>○ BIT Status (Built In Test)</li> <li>○ System Configuration</li> <li>○ External input and 1PPS output delay</li> <li>○ Configuration of:                             <ul style="list-style-type: none"> <li>SMTP</li> <li>SNMP (v1,v2,v3)</li> <li>SYSLOG</li> <li>SW UPLOAD</li> </ul> </li> <li>○ Authentication of:                             <ul style="list-style-type: none"> <li>LDAP</li> <li>RADIUS</li> </ul> </li> </ul>

All specs are at room temperature, quiescent conditions, sea level ambient unless otherwise specified

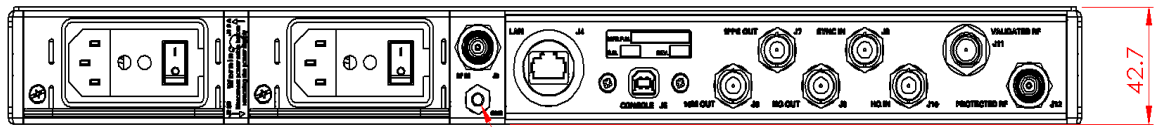

10-32 UNF

**BACK VIEW**

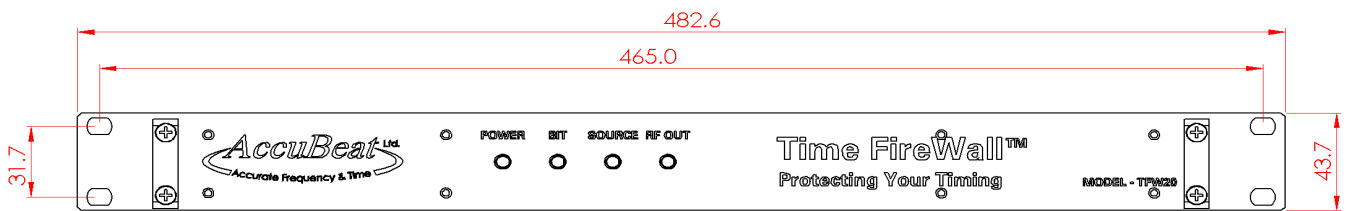

**FRONT VIEW**

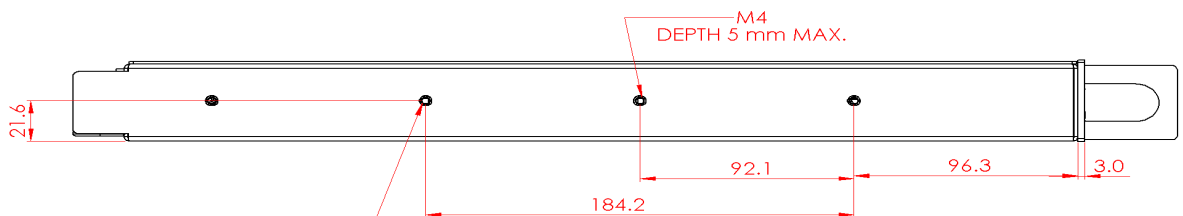

**SIDE VIEW**

MOUNTING FOR SLIDES:  
 375QD-20 (JONATHAN)  
 69000-541 (SCHROFF)  
 S-300-S-120 (General Devices)

**Mechanical dimensions & Weight**

Dimensions	19" / 1U Rack mount Depth: 280 mm Option for slides
Weight	≤ 5 Kg

All specs are at room temperature, quiescent conditions, sea level ambient unless otherwise specified

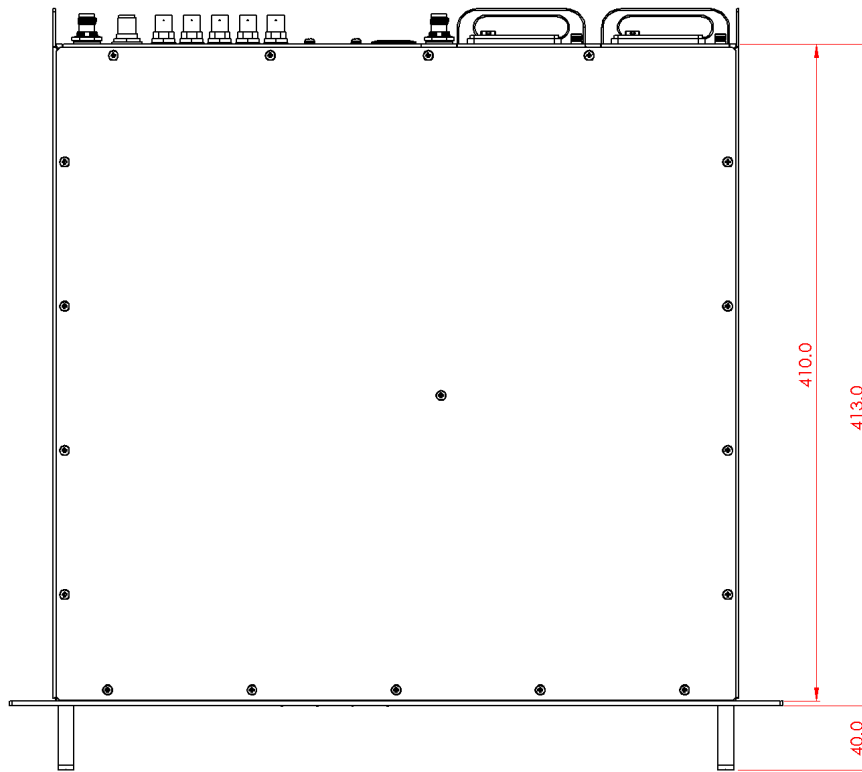

AccuBeat Ltd, 5 Ha'Marpeh St., Har Hotzvim, P.O.Box 45012, Jerusalem 91450, Israel  
Tel: +972-2-5868330, Fax: +972-2-5868550, E-Mail: [marketing@accubeat.com](mailto:marketing@accubeat.com)  
<http://www.accubeat.com>